



**KS-N15**  
**KS-N15 Pro**  
**KS-N15 Pro+**  
**User**  
**Manual**



# Cautions

Electric scooter is a recreational personal transporter. Before mastering riding skills, you need to do practice. You will be responsible for any injuries or damage caused by a rider's inexperience or failure to follow the instructions in this manual.

Please understand that you can reduce the risk by following all the instructions or warnings in this manual, but you cannot eliminate all the risks.

Please following the local traffic laws or restrictions when riding into public areas.

Please always wear a helmet properly when riding to protect your head, as well as other necessary protectors, such as elbow pads, kneecap.

Please slow down the riding speed when riding on crossing, going across the crowd, making a turn, climbing or downing a hill, passing a school and other place that high speed may bring damage to people.

Please do not allow kids of age below 12 to use the scooter on public area. Riders under the age of 18 years old should ride under adult supervision.

Please do not use the scooter in serious environments, to avoid scooter malfunction, which may cause damage to body or property, such as Rainy, Snowfield, Grassland, Muddy, Fog, Smoke and so on.

Please do not use the other chargers to charge E-scooter, Only use King Song supplied charger.

Please do not charge E-scooter, if the charger or power outlet is wet.

Please do not disassemble the scooter body or other modify without professional person from distributors.

Please do not allow others to ride your e-scooter unless he/her has carefully read and follow the instructions in this manual.

# Contents

1. Product Details-----	01
2. Features -----	04
3. Button Usage -----	05
4. Assembly and Set-up-----	06
5. APP Usage -----	07
6. Learn to Ride-----	08
7. Safety Instruction-----	10
8. Cruise Control-----	13
9. Error Description-----	14
10. Folding and Carrying-----	17
11. Adjusting the disc brake-----	18
12. Adjust the handlebar-----	19
13. Battery-----	19
14. Clean and Maintenance-----	20
15. Warranty-----	22

# 1. Product Details

## 1.1 Diagram: KS-N15 / KS-N15 Pro / KS-N15 Pro+



### Accessories

---



Screws



Hex Wrench



Charging Adapter



User Manual

## 1.2 Functions

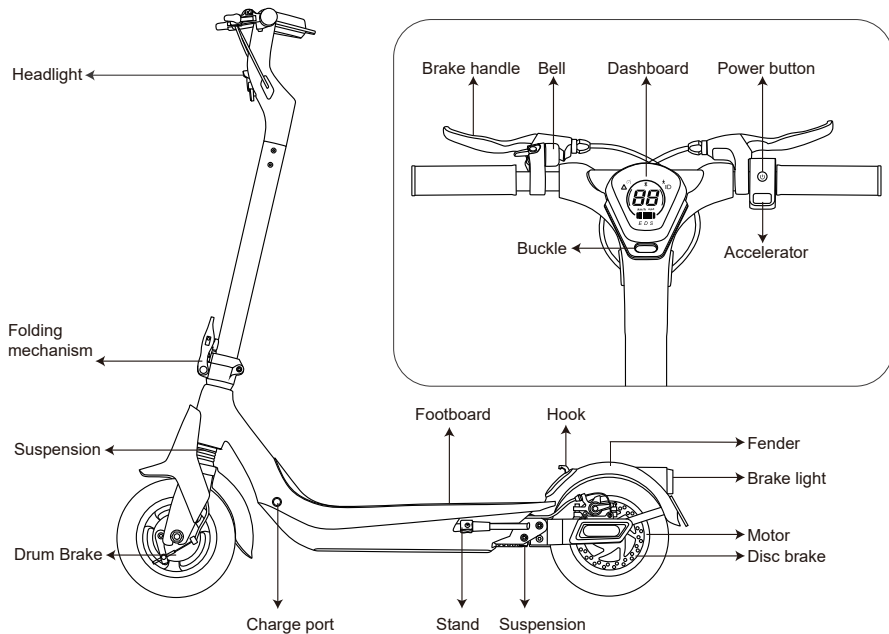

### 1.3 Specifications

Model No	KS-N15	KS-N15 Pro	KS-N15 Pro+
Size	10 inch Inner Honeycomb Tyre / Inflatable Tyre		
Top Speed	30km/h	30km/h	35km/h
Mileage	Around 20km	Around 40km	Around 60km
Grade-ability	Around 22%	Around 25%	Around 47%
Battery Capacity	37V, 6Ah	37V, 10.4Ah	48V, 14.5Ah
Running Condition	-10 °C/+50 °C ; 0-85% Humidity		
Storage Condition	-20 °C/+60 °C ; 0-85% Humidity		
Max Load	120kg		
Charger	Input AC: 100-240V; Output DC: 42V/2A	Input AC: 100-240V; Output DC: 42V/2A	Input AC: 100-240V; Output DC: 54.6V/2A
Charging Time	Around 3-4hrs	Around 6-7hrs	Around 7-8hrs
Motor	350W	500W	600W
Port	Charge Port *1		
Headlight	1.5W		
Brake Light	LED		
User Height	150-200cm		



Parking Mode	Kick-stand		
Cruise Control	System Control		
Suspension	Front and Rear Suspension		
Reminder	Mechanical Bell		
Accelerator	Throttle Button		
Brake	Front Drum Brake + Rear Disc Brake + EABS		
Display	LED		
Battery Display	5 Bars in monitor		
Dimension(Unfold)	1165* *535*1201mm		
Dimension(Folded)	1165* *535*540mm		
Net Weight	21.4kg	21.9kg	22.7kg
Packing List(pcs)	User Manual*1, Certificate*1, Charger*1, Screws*6, Hex Wrench*1		

## 2. Features

- Steel Alloy.
- Real-time Temperature Monitoring, Short Circuit / Low Voltage / Overcurrent / Overcharging Protection.
- Digital Speedometer Display, Easy to Read Speed.

- Real-time 5 Bars Battery Display.
- 1~4 Speed Gear, Press Button to Switch.
- Malfunction Display.

### 3. Button Usage

- Power ON/OFF: Long press the button for 3 seconds, all icons are lighting, showing speed & battery.



- Headlight ON/OFF: Click the button (Headlight ON: ≡D)

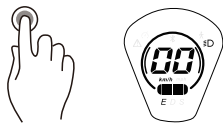

- Click the button for 2 times to change the speed gear from 1 to 4 levels, LED display P1 / P2 / P3 / P4. Max speed is increasing when LED display from P1 to P3. P4 is a pedestrian mode with a maximum speed of 6km/h.

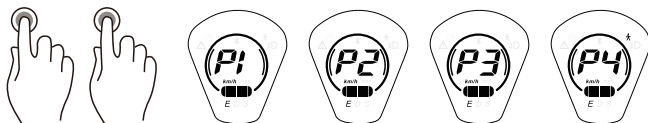

## 4. Assembly and Set-up

1. Unfold the handlebar stem and fasten it.

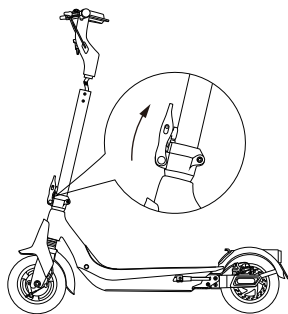

2. Connect wires inside the pole, and install head on it .Pull the brake wire from the silicone plug,leave 20mm outside.

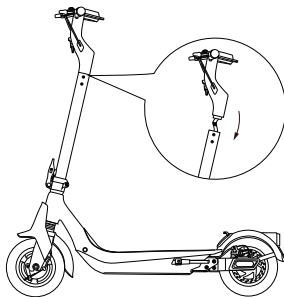

4. Tighten the screws onto three sides of the stem with the hexagon wrench.

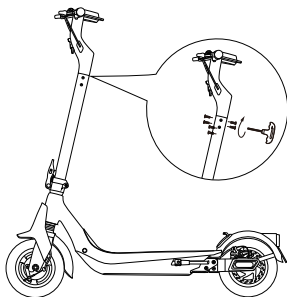

4. After the assembly, press the power button to check if it's working properly.

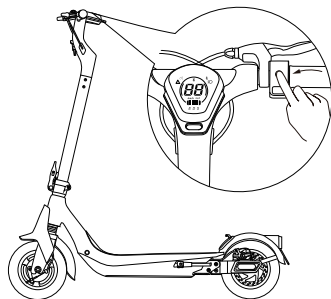

## 5. APP Usage

### 5.1 First Ride

Mobile device Requirement:

iOS 10.0 or above,  
Bluetooth 4.0 or above.

Install the APP and register/login.

Android 4.3 or above,  
Install the APP and register/login.



iOS



Android



**Please give the corresponding permission to scooter APP, to ensure the APP can run normally in your mobile device.**

Open Bluetooth/location (or GPS), Click 'Search' -> Click the corresponding model KS-N15 in device list to connect. The E-scooter will beep when APP is connected with E-scooter.

## **6. Learn to Ride**

- Step 1: Check E-scooter Status

Check the environment whether it's safe to ride without hurting yourself or others.

Check the battery level and remain mileage in APP.

- Step 2: Wear protective equipment.

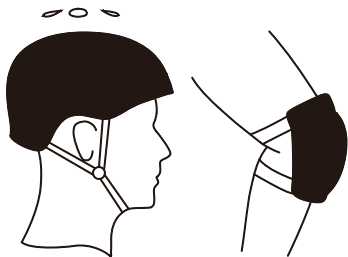

- Step 3: Try to slide with one leg.



- Step 4: Touch the throttle slightly and try to put two leg on the deck.

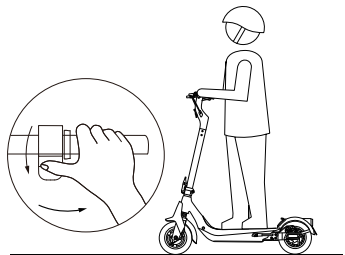

- Step 5: During riding, try to release the throttle and pull the brake lever.

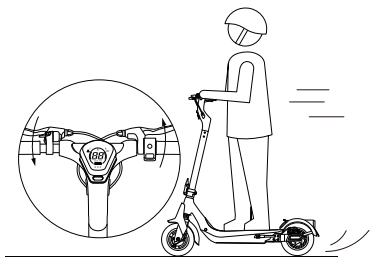

- Step 6: Try to use the headlight.

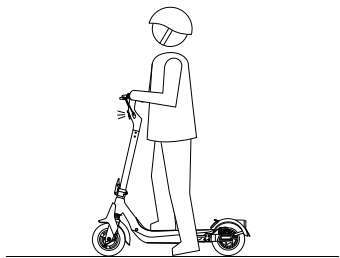

## 7. Safety Instruction

- Wear protective equipment.
- Avoid riding in the rain when possible.

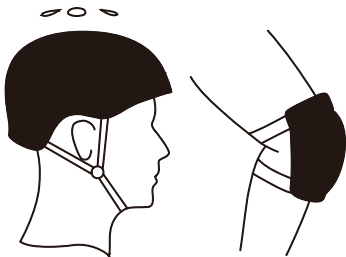

- Do not load over 120kg.

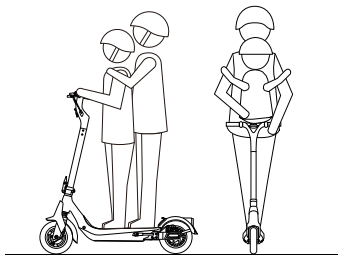

- Ride slowly in special cases.

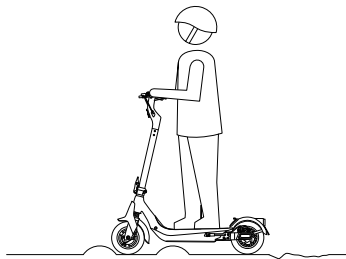

- Do not place one foot on the deck or on the ground when riding.



- Do not tread the back of the fender.





- Do not touch the disc brake.
- Do not leave your hands during riding.

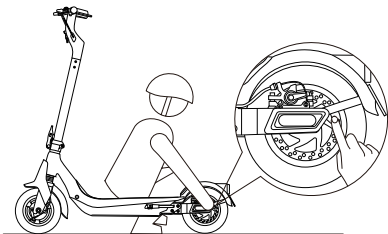

- Do not ride upstairs or downstairs, or over obstacles.
- Do not hold a child during riding.

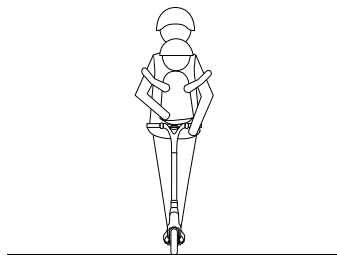
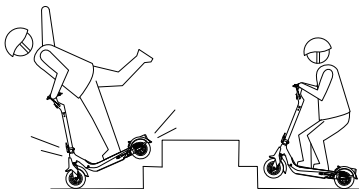

- Do not ride on highway or motor vehicle road.
- Do not ride with sharp turn.

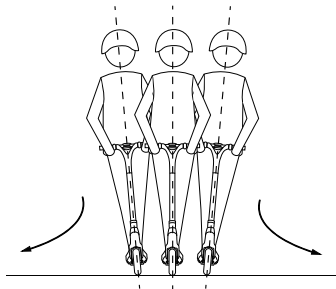
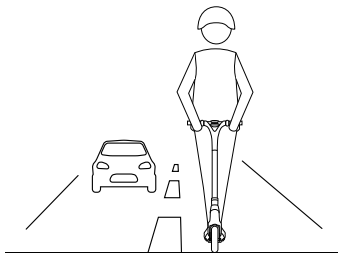

## 8. Cruise Control

Open cruise-control in APP, while you keep the same speed, riding for 3~5 seconds, the E-scooter will be in cruise-control mode(running at constant speed on flat road) Please use cruise-control only on flat road, or you will fall down on other roads.

## 9. Error Description

Display	Defect Description	Solutions
E0	Wrong in communication	<ol style="list-style-type: none"><li>1. Check whether the display control board is well connected;</li><li>2. Replace the display.</li><li>3. Replace the control board.</li></ol>
E1	Encounter obstacles that E-scooter can't get over it	<ol style="list-style-type: none"><li>1. Release the accelerator and stop braking.</li><li>2. Restart.</li><li>3. Replace the brake lever.</li><li>4. Replace the accelerator.</li></ol>
E3	Hall is abnormal	<ol style="list-style-type: none"><li>1. Check whether the Hall wire plug of the motor is loose.</li><li>2. Check whether the motor cable is damaged.</li><li>3. Replace the motor.</li><li>4. Replace the control board.</li></ol>
E4	Brake system malfunction	<ol style="list-style-type: none"><li>1. Release the brake.</li><li>2. Restart.</li><li>3. Replace the brake lever.</li></ol>
E5	Throttle fault	<ol style="list-style-type: none"><li>1. Release the accelerator.</li><li>2. Restart.</li><li>3. Replace the accelerator.</li></ol>

BL	Low voltage alarm	<ol style="list-style-type: none"> <li>1. Stop riding and get scooter charged.</li> <li>2. Restart.</li> <li>3. Check if firmware has been wrongly upgraded.</li> <li>4. Replace the control board.</li> </ol>
BH	High voltage alarm	<ol style="list-style-type: none"> <li>1. Check whether scooter has been fully charged, riding the scooter at low speed, avoiding braking suddenly when scooter is fully charged.</li> <li>2. Restart.</li> <li>3. Check if firmware has been wrongly upgraded.</li> <li>4. Replace the control board.</li> </ol>
BP	Over voltage, emergency	<ol style="list-style-type: none"> <li>1. Check whether scooter has been fully charged, riding the scooter at low speed, avoiding braking suddenly when scooter is fully charged.</li> <li>2. Restart. Check if firmware has been wrongly upgraded.</li> <li>3. Replace the control board.</li> </ol>
H1	Motor high temperature	<ol style="list-style-type: none"> <li>1. Stop riding or riding scooter at low speed, avoiding climbing.</li> </ol>

		<ol style="list-style-type: none"> <li>2. Check whether the motor wire is damaged, and whether the temperature signal wire of the motor wire is short-circuited to the ground.</li> <li>3. Replace the motor.</li> </ol>
H2	Control board high temperature	<ol style="list-style-type: none"> <li>1. Stop riding or riding scooter at low speed, avoiding climbing.</li> <li>2. Check the installation of control board radiator.</li> <li>3. Replace the control board.</li> </ol>
H3	Control board super high temperature	<ol style="list-style-type: none"> <li>1. Stop riding or riding scooter at low speed, avoiding climbing.</li> <li>2. Check the installation of control board radiator.</li> <li>3. Replace the control board.</li> </ol>
LR	Over current	<ol style="list-style-type: none"> <li>1. Release the accelerator.</li> <li>2. Restart.</li> <li>3. Replace the control board.</li> </ol>
S1	Short circuit	<ol style="list-style-type: none"> <li>1. Get the motor disconnected and restart up scooter. If this alarm has not been cleared, get control board replaced; otherwise, all-clear, replace the motor.</li> </ol>

S2	Lack of phase, mos tube drive failure	<ol style="list-style-type: none"> <li>1. Restart and turn scooter on as static, avoiding turning on scooter while advancing.</li> <li>2. Replace the control board.</li> </ol>
SN	Lack of series number	<ol style="list-style-type: none"> <li>1. Check whether the firmware version is correct.</li> <li>2. Reset the serial number.</li> </ol>

## 10. Folding and Carrying

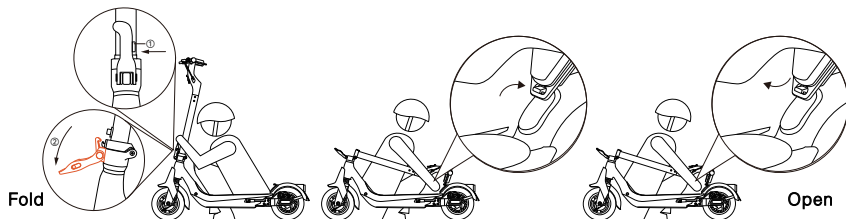

Make sure that the scooter's turned off. To fold, unlock the folding mechanism, and bend the handlebar stem to hook the buckle , To open, remove the hook from the buckle, erect the handlebar and lock the folding structure.

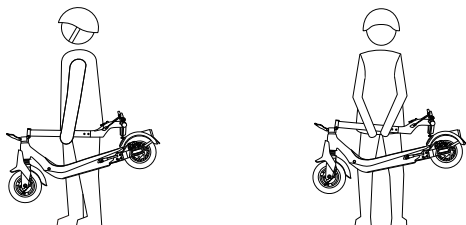

Carry

Hold the handlebar stem with either one hand or both hands to carry.

## 11. Adjusting the disc brake

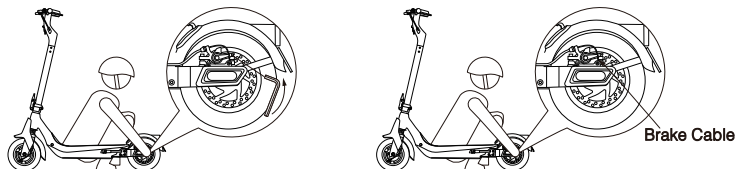

If the brake is too tight, use the hexagon wrench to loosen the screws on the caliper, and slightly send back the brake cable to shorten the exposed length, then tighten the screws. If the brake is too loose, loosen the screws, and slightly pull out the brake cable to lengthen the exposed length, then tighten the screws.

## 12. Adjust the handlebar

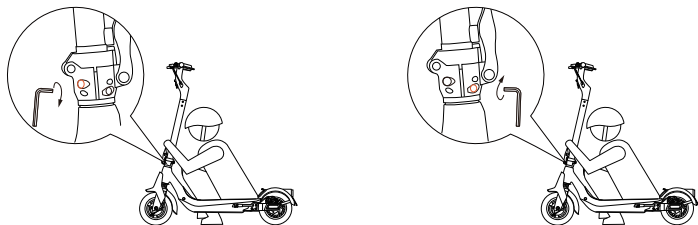

If the handlebar and its stem sway during riding, use the hexagon wrench to tighten the screws on the folding mechanism.

## 13. Battery

### 13.1 Temperature Effect on Battery

Battery power will vary with the temperature, mileage per charge will have slight difference under different temperature, and following table is just for your reference.

Temperature(°C)	-20	-10	0	10	20	30	40	50
Range	40%	60%	80%	90%	95%	100%	105%	110%



## **13.2 Charging**

The device has a built-in lithium battery, no extra battery installation is required, just charge the device when it indicates low battery.

Plug in the power source after inserting the charger plug, this can prevent potential risk to ensure a safer charger.

It takes around 3-4hrs(N15)/6-7hrs(N15 Pro) /7-8hrs (N15 Pro+) to get 100% charged, when the red lights turn into green, indicating the charging is completed.

If not in urgent need, please wait until charging complete before unplugging, for after charging, the protection circuit will perform flow equilibrium.

## **14. Clean and Maintenance**

### **14.1 Clean and Maintenance**

#### **When charging**

- Please place the E-scooter in cool and ventilate places to release heat.
- Please avoid high temperature or moist.
- Please avoid water into the E-scooter to prevent electric shock, especially water drops from the charger cable to the the charging port.

## **When cleaning**

- Please make sure the E-scooter is off.
- Please use soft cloth to clean the E-scooter.
- Please don't use water to wash the E-scooter or place E-scooter in water.

## **When storage**

- Please place the E-scooter in cool and ventilate places (temperature -20~60 ℃ , relative humidity 0~85%).
- Please don't place subjects on the E-scooter or heavy subjects to squeeze the E-scooter.

## **14.2 Battery Pack Maintenance**

When the E-scooter is fully charged, please check the voltage of the battery in APP. Normal voltage is 48V-54.6V (N15 Pro+) / 37V-42V (N15/N15 Pro).

If the voltage is not in this range, please contact the distributor for battery pack maintenance.

Please charge the E-scooter at least one time each month, to extend the battery pack lift time.

Please do not disassemble, assemble or change the battery by yourself.

## **14.3 Regular Maintenance**

Please do not disassemble or assemble the E-scooter

without the guide or help from professional maintenance from the seller or distributors.

Please make a video or photo to distributors when the E-scooter run abnormally, as well as providing the serial number.

Check the tire pressure before riding; if the tire pressure is insufficient, please inflate it in time; the recommended tire pressure is 250-300kPa, and the maximum tire pressure is 300-350kPa.

## Attentions before riding

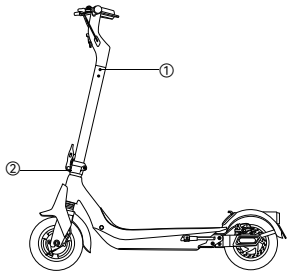

Check ①② of the scooter before riding. Firm or not. Tighten the screws if there is any sign of loosening.

### **Note:**

The fixed screw torque of ① is 4N/m;

The fixed screw torque of ② is 14N/m.

## 15. Warranty

For warranty policy, please consult with the point of purchase or email to the manufacturer's service team:

**[support@szkingsong.com](mailto:support@szkingsong.com)**

Again, we appreciate your purchasing of Kingsong products.

## **Kingsong Intell Co.,LTD**

Address : BLDG 7, NO 71 XINGHU RD, 8TH INDUSTRY PARK,  
HONGXING, YUTANG, GUANGMING, SHENZHEN

Tel : +86-755-23193477

Fax : +86-755-23193248

E-mail : [info@szkingsong.com](mailto:info@szkingsong.com)